

MICRO-CON-X[®]
SEALED CONNECTORS
AND CABLES



Switchcraft[®]
CONXALL[®]
HARSH ENVIRONMENT CONNECTIVITY SOLUTIONS

Micro-Con-X® Sealed Connectors

Thousands of configurations are available up to 7 contacts with a variety of options

Coupling rings have overriding locking features to prevent loosening or separation of connector



Available as field installable connectors or factory molded cable assemblies

Compact size fits in a 0.43" [10.9mm] mounting hole

CONXALL® PRODUCT

The Micro Con X® series from Conxall® sets the standard for harsh environment connectors. It is built to withstand harsh environments with an IP67/IP69K seal rating, and a 600V voltage rating makes it an ideal solution for power or signal. Thousands of configurations are available up to 7 contacts, including standard off the shelf or custom molded cable assemblies.

IP67/IP69K
RATED WATER
RESISTANCE

The Con-X® series is sealed to IP67/IP69K for harsh environments when used with a molded cable assembly.



600V VOLTAGE
RATING

600V voltage rating makes it an ideal solution for power or signal.



CONXALL
QUALITY

Made in USA to the high standards that have made Conxall the leading name in harsh environment connectors.

MICRO-CON-X® LINE



CABLE END - SOCKET

MATES WITH PANEL MOUNT AND
CABLE TO CABLE



CABLE END - PIN

MATES WITH PANEL MOUNT AND
CABLE TO CABLE



CABLE TO CABLE / INLINE - SOCKET

MATES WITH CABLE END



PANEL MOUNT - PIN

MATES WITH CABLE END



PANEL MOUNT - SOCKET

MATES WITH CABLE END



DUST CAP

P/N - 16295



IP RATED LOCKING CAP

P/N-16295P (2-3 Contacts)



MOLDED CABLE END ASSEMBLY



MOLDED CABLE TO CABLE ASSEMBLY



MOLDED RIGHT ANGLE CABLE ASSEMBLY

INSTA-CLICK®
AVAILABLE

- Automatic Positive Lock
- IP68 Seal Rating
- UL F1 Rated UV Resistance



FIELD INSTALLABLE KITS

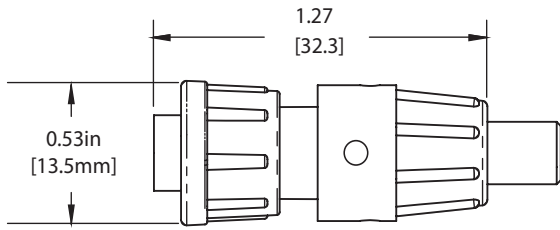

16XXX-XXG-3XX
FIELD INSTALLABLE
CABLE CONNECTOR
BACKSHELL TYPE 3-SHORT
2 & 3 POSITION ONLY

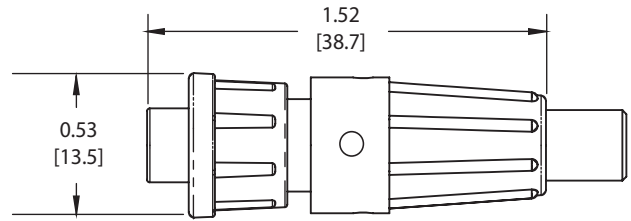

16XXX-XXG-5XX
FIELD INSTALLABLE
CABLE CONNECTOR
BACKSHELL TYPE 5-LONG

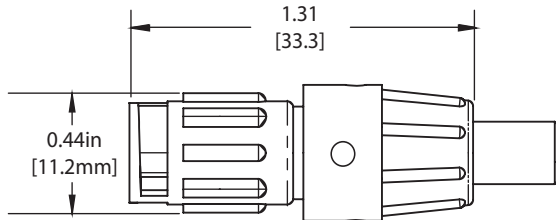

18XXX-XXG-3XX
FIELD INSTALLABLE
CABLE TO CABLE CONNECTOR
BACKSHELL TYPE 3-SHORT
2 & 3 POSITION ONLY

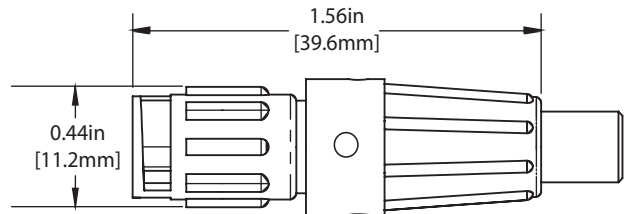

18XXX-XXG-5XX
FIELD INSTALLABLE
CABLE TO CABLE CONNECTOR
BACKSHELL TYPE 5-LONG

PANEL MOUNT ASSEMBLY KITS

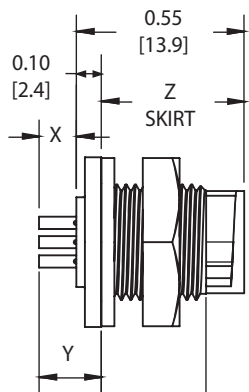

17X80-XXG-3XX
PANEL MOUNT CONNECTOR
CRIMP

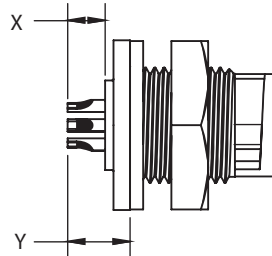

17X82-XXG-3XX
PANEL MOUNT CONNECTOR
SOLDER CUP

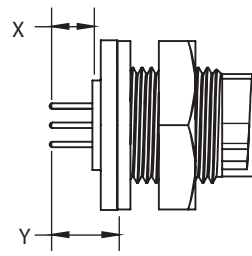

17X8X-XXG-3XX
PANEL MOUNT CONNECTOR
PC TAIL

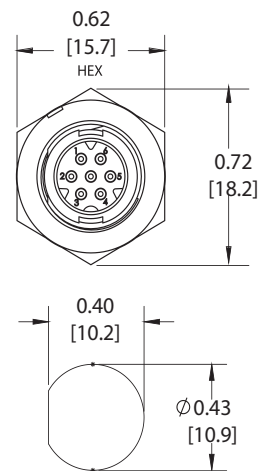

RECOMMENDED
PANEL CUT-OUT
TOLERANCE: ±.003

PANEL MOUNT / CABLE TO CABLE CONNECTORS

Front View | Wire View

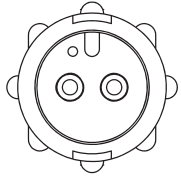

2 POSITION
#20 PIN & SOCKET
CONTACT

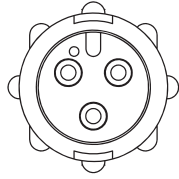

3 POSITION
#20 PIN & SOCKET
CONTACT

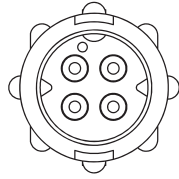

4 POSITION
#22 PIN & SOCKET
CONTACT

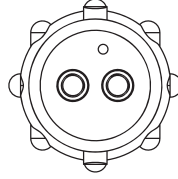

2 POSITION
#20 PIN & SOCKET
CONTACT

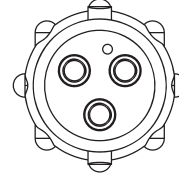

3 POSITION
#20 PIN & SOCKET
CONTACT

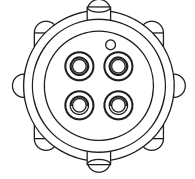

4 POSITION
#22 PIN & SOCKET
CONTACT

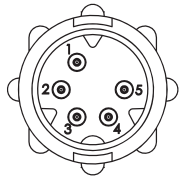

5 POSITION B-KEY
#26 PIN & SOCKET
CONTACT

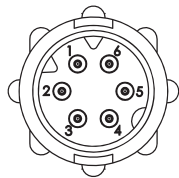

6 POSITION A-KEY
#26 PIN & SOCKET
CONTACT

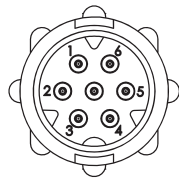

7 POSITION B-KEY
#26 PIN & SOCKET
CONTACT

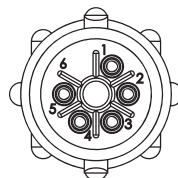

5 POSITION B-KEY
#26 PIN & SOCKET
CONTACT

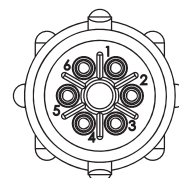

6 POSITION A-KEY
#26 PIN & SOCKET
CONTACT

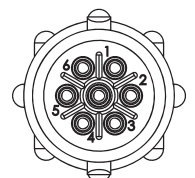

7 POSITION B-KEY
#26 PIN & SOCKET
CONTACT

CABLE CONNECTORS

Front View | Wire View

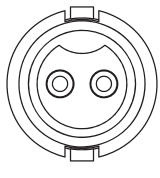

2 POSITION
#20 PIN & SOCKET
CONTACT

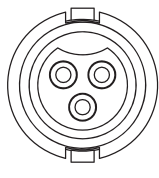

3 POSITION
#20 PIN & SOCKET
CONTACT

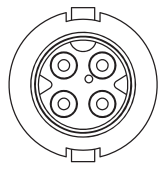

4 POSITION
#22 PIN & SOCKET
CONTACT

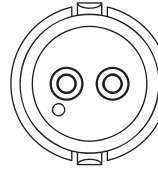

2 POSITION
#20 PIN & SOCKET
CONTACT

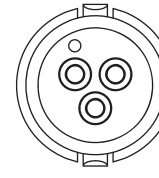

3 POSITION
#20 PIN & SOCKET
CONTACT

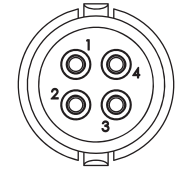

4 POSITION
#22 PIN & SOCKET
CONTACT

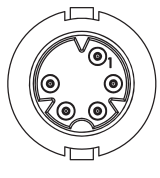

5 POSITION B-KEY
#26 PIN & SOCKET
CONTACT

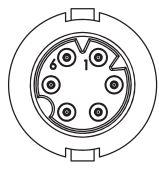

6 POSITION A-KEY
#26 PIN & SOCKET
CONTACT

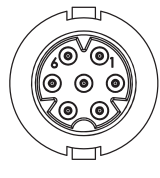

7 POSITION B-KEY
#26 PIN & SOCKET
CONTACT

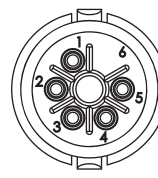

5 POSITION B-KEY
#26 PIN & SOCKET
CONTACT

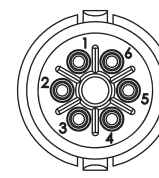

6 POSITION A-KEY
#26 PIN & SOCKET
CONTACT

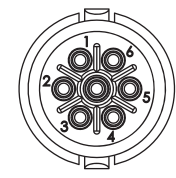

7 POSITION B-KEY
#26 PIN & SOCKET
CONTACT

All dimensions are for reference only. Units shown: in[mm].

CUSTOM MOLDED CABLE ASSEMBLIES

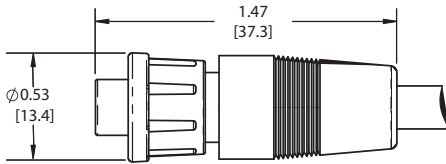

16XXX-XXG
CABLE CONNECTOR
STRAIGHT OVERMOLDED

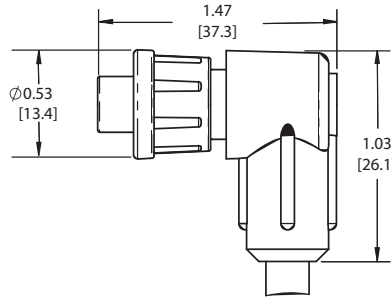

16XXX-XXG
CABLE CONNECTOR
RIGHT ANGLE OVERMOLDED

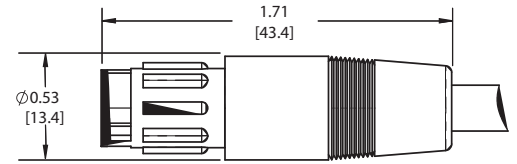

18XXX-XXG
CABLE TO CABLE CONNECTOR
STRAIGHT OVERMOLDED

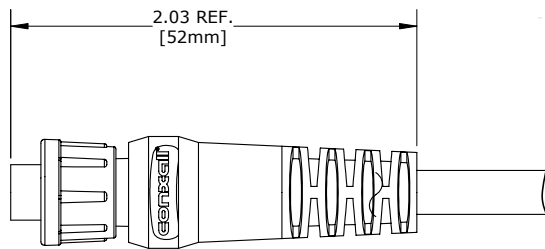

CA16280PXXX90
CUSTOM CABLE CONNECTOR
STRAIGHT OVERMOLDED
FLEX RELIEF STYLE

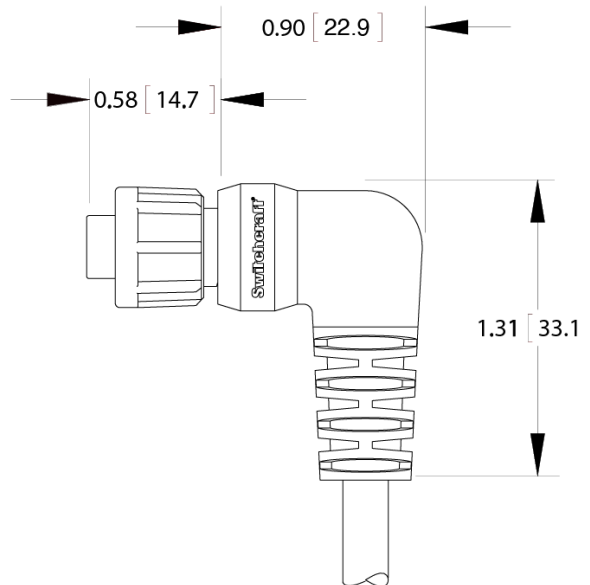

CA16280SXXX90
CUSTOM CABLE CONNECTOR
RIGHT ANGLE OVERMOLDED
FLEX RELIEF STYLE

Configuration	Micro-Con-X® Part Number
Straight, 2-pos, Male, 2 Meter	CA162802P07990
Straight, 2-pos, Female, 2 Meter	CA162802S07990
Straight, 3-pos, Male, 2 Meter	CA162803P07990
Straight, 3-pos, Female, 2 Meter	CA162803S07990
Straight, 4-pos, Male, 2 Meter	CA168804P07990
Straight, 4-pos, Female, 2 Meter	CA168804S07990
Right Angle, 2-pos, Male, 2 Meter	CARA162802P07990
Right Angle, 2-pos, Female, 2 Meter	CARA162802S07990
Right Angle, 3-pos, Male, 2 Meter	CARA162803P07990
Right Angle, 3-pos, Female, 2 Meter	CARA162803S07990
Right Angle, 4-pos, Male, 2 Meter	CARA168804P07990
Right Angle, 4-pos, Female, 2 Meter	CARA168804S07990

PART NUMBER TO ORDER

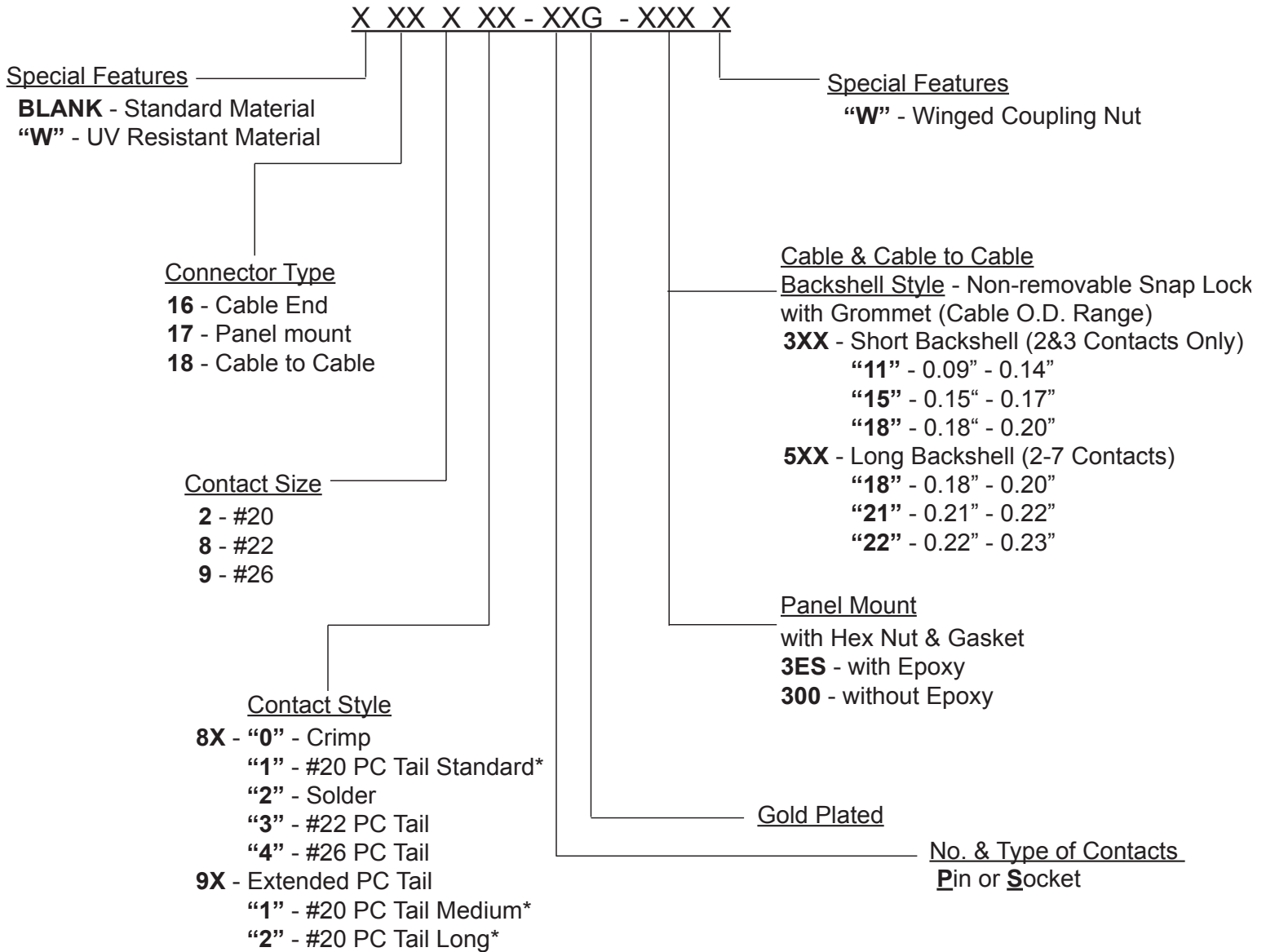

*Consult factory for length and diameter of PC Tail. Additionally, alternative colors and materials are available
 Visit switchcraft.com for Insta-Click® ordering code.

COLOR CODED CON-X[®] LINE



CC2



CH2



CC3



CH3



CC5



CH5



CC7



CH7

ORDERING CODE

Added to the end of your standard Con-X part number

When ordering, use the following code to specify your special feature:

Special Features

CXX = Color Options

└─ Color Designator - see below

└─ Part Designator - see below

└─ Special Feature Designator - see below

Special Feature Designator = C (Color Option)

Part Designator = H (Hex Nut)

C (Coupling Ring-standard)*

Color Designator= 2 (Red)

3 (Blue)

5 (Yellow)

7 (Green)

*Winged coupling ring available on request.
Contact factory for more information.

SPECIFICATIONS

MECHANICAL:

Life:	300 insertion / withdrawal cycles minimum
Vibration:	Coupling rings have overriding locking feature to prevent loosening/separation of connector
Hex Nut Torque:	9 in-lb tightening torque
Coupling Locking Style:	Bayonet with ribbed coupling nut (winged coupling nut available) P/N 16482
Backshell Style:	Non-removable snap lock
Conductor Sizes:	#20 accepts 20 through 24 AWG #22 contacts accepts 22 through 24 AWG #26 contacts accepts 24 through 26 AWG

ELECTRICAL:

Voltage Rating:	600 V AC/DC
Current Rating:	7.5 A - max (See Electrical Current Rating Chart)

ENVIRONMENTAL:

Operating Temperature:	-40°C to +85°C (-40°F to +185°F)
Salt Atmosphere (Corrosion) :	300 Hr salt spray when mated
Weathertight:	IP67/IP69K at the face, when mated

MATERIAL:

Backshell:	Thermoplastic, UL 94HB, Black
Contacts:	Copper Alloy, Gold over Nickel Plate
Coupling Ring:	Thermoplastic, UL 94HB, Black
Gasket:	Elastomer, Black
Grommet/ Strain Relief:	Elastomer, Black
Hex Nut:	Thermoplastic, UL 94HB, Black
O-Ring:	Elastomer, Black
Shell:	Thermoplastic, UL 94HB, Black
Optional Dust Cap:	Elastomer, Black

CON-X® ELECTRICAL CURRENT RATING CHART

CONTACT SIZE	CONDUCTOR SIZE - AWG	NUMBER OF CONDUCTORS	CURRENT RATING
#12	#12	1 through 7	23.0A
	#14	1 through 3	17.0A
		4 through 6	12.75A
		7 through 9	11.0A
	#16	1 through 3	13.0A
		4 through 6	9.75A
		7	8.45A
#16	#16	1 through 10	13.0A
		11 and 12	7.5A
	#18	1 through 3	10.0A
		4 through 12	7.5A
#20	#18	1 through 3	7.5A
		4 through 20	5.6A
		21 through 31	2.3A
	#20	1 through 3	7.5A
		4 through 20	5.6A
		21 through 31	2.3A
	#20 Multi-Con-X	10 through 12	5.0A
	#22	1 through 3	6.0A
		4 through 20	2.5A
		21 through 31	2.5A
	#24	1 through 3	4.5A
		4 through 20	2.0A
21 through 31		1.5A	
#22	#22	4	5.5A
	#24	4	5.0A
#26	#24	5 to 6	4.0A
	#24	7	3.5A
	#26	5 to 6	2.5A
	#26	7	2.5A
	#28*	5 to 6	2.0A
	#28*	7	2.0A

*Not UL tested for this wire conductor size