

CUSTOMER PRINT

PART NUMBER: W6282-XSG-P-3XX

**NOTES:**

1. ALL PARTS TO BE BULK PACKED.
2. SEE DRAWING HPMISTD FOR HOLE PATTERN.
3. ALL DIMENSIONS ARE REFERENCE ONLY. DIMENSIONS IN [ ] ARE METRIC.

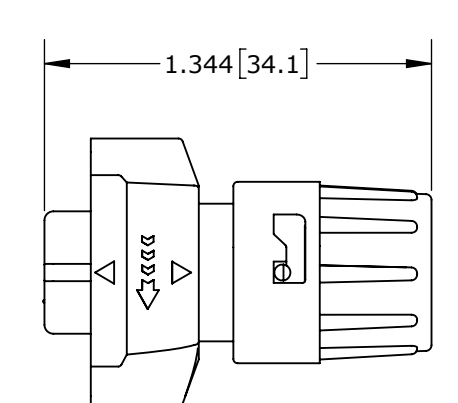

**SHOWN ASSEMBLED KIT**  
ASSY: W6282-2SG-P-3XX SHOWN

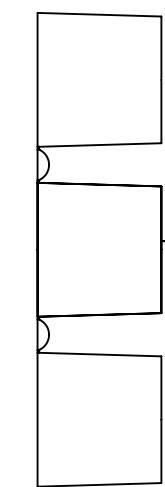

DAISY CHAIN GROMMETS (3DC)  
.125 I.D. FOR CABLES .09-.14 [2.3 - 3.6] O.D.  
.188 I.D. FOR CABLES .18-.20 [4.6 - 5.1] O.D.  
.250 I.D. FOR CABLES .24-.26 [6.1 - 6.6] O.D.

CABLE-END CONNECTOR P/N	CONTACTS
W6282-2SG-P-3XX	2 #20
W6282-3SG-P-3XX	3 #20
W6282-4SG-P-3XX	4 #20
W6282-5SG-P-3XX	5 #20
W6282-6SG-P-3XX	6 #20
W6282-7SG-P-3XX	7 #20
W6282-8SG-P-3XX	8 #20
W6282-XSG-P-3XX	

GROMMET SIZE:  
**3DC** FOR DAISY CHAIN GROMMETS  
**3XX** FOR SINGLE GROMMET SIZE PER LIST ON THIS DRAWING.

NUMBER OF CONTACTS

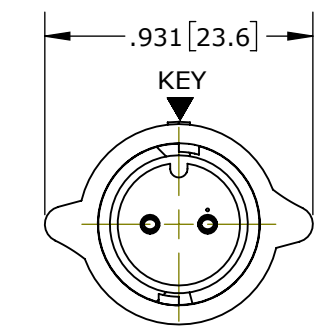

**MATING FACE**  
ASSY: W6282-2SG-P-3XX SHOWN

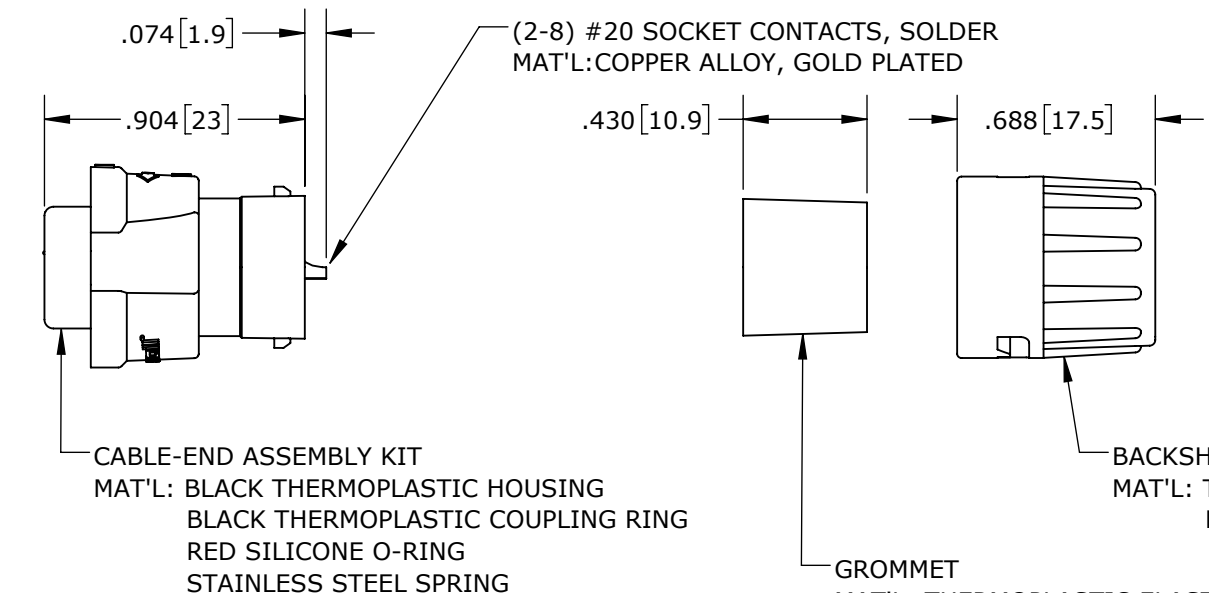

CABLE-END ASSEMBLY KIT  
MAT'L: BLACK THERMOPLASTIC HOUSING  
BLACK THERMOPLASTIC COUPLING RING  
RED SILICONE O-RING  
STAINLESS STEEL SPRING

GROMMET  
MAT'L: THERMOPLASTIC ELASTOMER, BLACK  
GROMMET SINGLE SIZE = CABLE O.D. RANGE:  
**311:** .125 I.D. FOR CABLES .09-.14 [2.3 - 3.6] O.D.  
**315:** .156 I.D. FOR CABLES .15-.17 [3.8 - 4.3] O.D.  
**318:** .188 I.D. FOR CABLES .18-.20 [4.6 - 5.1] O.D.  
**321:** .225 I.D. FOR CABLES .21-.23 [5.3 - 5.8] O.D.

BACKSHELL  
MAT'L: THERMOPLASTIC, BLACK

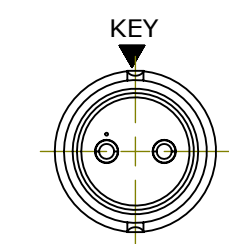

**WIRING END**  
ASSY: W6282-2SG-P-3XX SHOWN WITHOUT HARDWARE

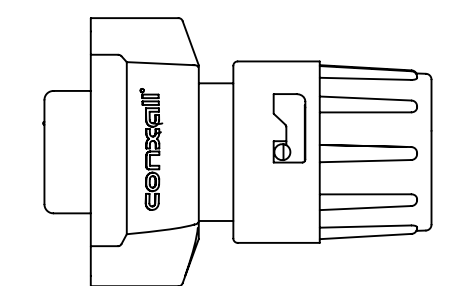

**SHOWN ASSEMBLED KIT**  
ASSY: W6282-2SG-P-3XX SHOWN

**CUSTOMER APPROVAL**

THIS DOCUMENT CONTAINS CONFIDENTIAL INFORMATION PROPRIETARY TO CONXALL CORPORATION. ANY REPRODUCTION, DISCLOSURE, OR USE OF THIS DOCUMENT / INFORMATION IS EXPRESSLY PROHIBITED UNLESS AUTHORIZED IN WRITING BY CONXALL CORPORATION.

APPROVED BY: \_\_\_\_\_  
DATE: \_\_\_\_\_

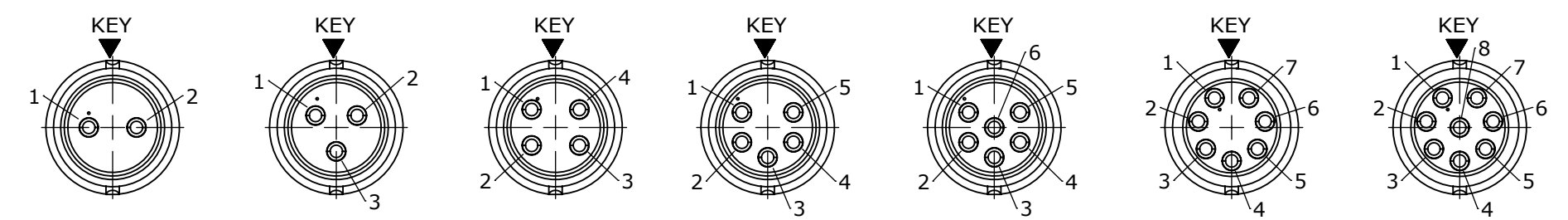

**WIRING END** W6282-2SG-P-3XX    **WIRING END** W6282-3SG-P-3XX    **WIRING END** W6282-4SG-P-3XX    **WIRING END** W6282-5SG-P-3XX    **WIRING END** W6282-6SG-P-3XX    **WIRING END** W6282-7SG-P-3XX    **WIRING END** W6282-8SG-P-3XX

**RoHS COMPLIANT**

0A	PNK	05-10-19	PDR 16014
REV.	INIT.	DATE	DESCRIPTION
	PNK	05-10-19	ORIG. DRAWN BY: DATE: 05-10-19
ALL INFORMATION ILLUSTRATED IS THE PROPERTY OF CONXALL CORPORATION. UNAUTHORIZED DUPLICATION OR DISTRIBUTION OF THIS DOCUMENT IS PROHIBITED.			<p>601 E. WILDWOOD VILLA PARK, IL 60181</p>
UNLESS OTHERWISE SPECIFIED TOLERANCES: 3 PLACE DECIMALS ±0.010 ANGLES ±1° FRACTIONS ±1/16			
APPROVED BY:		TITLE: CABLE-END ASSEMBLY 2-8 #20 SOCKET CONTACTS, SOLDER INSTA-CLICK™ MINI-CON-X	
SCALE: NTS	SIZE: B	SHEET: 1 OF 1	CUSTOMER: STANDARD PRODUCT
FILE: W6282-XSG-P-3XX	DIRECTORY: SLW	PART NUMBER: W6282-XSG-P-3XX	REV: 0A