

CUSTOMER PRINT

PART NUMBER: W6282-XPG-P-3XX

NOTES:

1. ALL PARTS TO BE BULK PACKED.
2. SEE DRAWING HPMISTD FOR HOLE PATTERN.
3. ALL DIMENSIONS ARE REFERENCE ONLY. DIMENSIONS IN [] ARE METRIC.

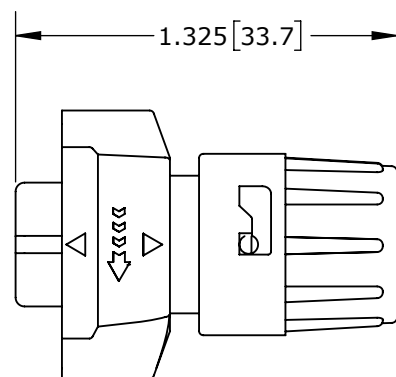

SHOWN ASSEMBLED KIT
ASSY: W6282-2PG-P-3XX SHOWN

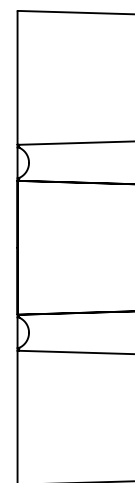

DAISY CHAIN GROMMETS (3DC)
.125 I.D. FOR CABLES .09-.14 [2.3 - 3.6] O.D.
.188 I.D. FOR CABLES .18-.20 [4.6 - 5.1] O.D.
.250 I.D. FOR CABLES .24-.26 [6.1 - 6.6] O.D.

CABLE-END CONNECTOR P/N	CONTACTS
W6282-2PG-P-3XX	2 #20
W6282-3PG-P-3XX	3 #20
W6282-4PG-P-3XX	4 #20
W6282-5PG-P-3XX	5 #20
W6282-6PG-P-3XX	6 #20
W6282-XPG-P-3XX	

GROMMET SIZE:
3DC FOR DAISY CHAIN GROMMETS
3XX FOR SINGLE GROMMET SIZE PER LIST ON THIS DRAWING.

NUMBER OF CONTACTS

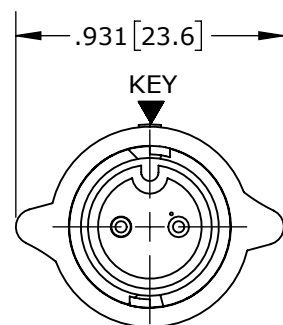

MATING FACE
ASSY: W6282-2PG-P-3XX SHOWN

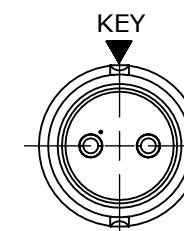
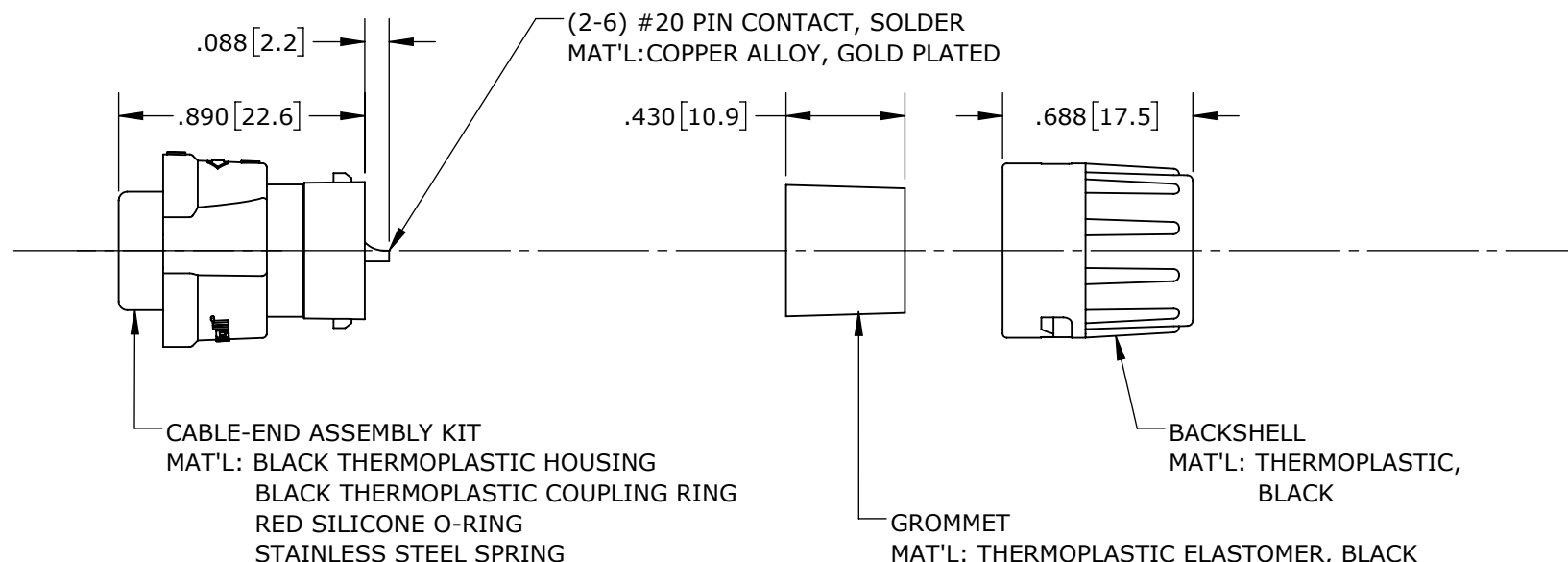

WIRING END
ASSY: W6282-2PG-P-3XX SHOWN WITHOUT HARDWARE

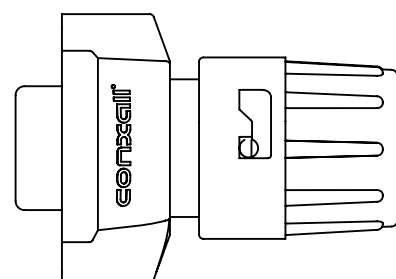

SHOWN ASSEMBLED KIT
ASSY: W6282-2PG-P-3XX SHOWN

CUSTOMER APPROVAL

THIS DOCUMENT CONTAINS CONFIDENTIAL INFORMATION PROPRIETARY TO CONXALL CORPORATION. ANY REPRODUCTION, DISCLOSURE, OR USE OF THIS DOCUMENT / INFORMATION IS EXPRESSLY PROHIBITED UNLESS AUTHORIZED IN WRITING BY CONXALL CORPORATION.

APPROVED BY: _____

DATE: _____

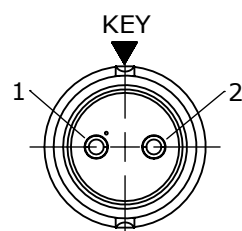

WIRING END
W6282-2PG-P-3XX

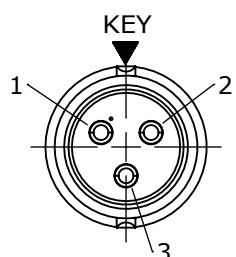

WIRING END
W6282-3PG-P-3XX

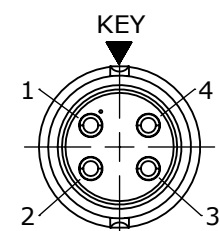

WIRING END
W6282-4PG-P-3XX

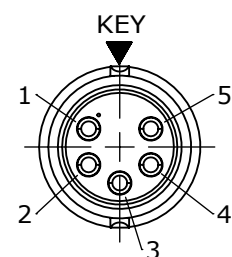

WIRING END
W6282-5PG-P-3XX

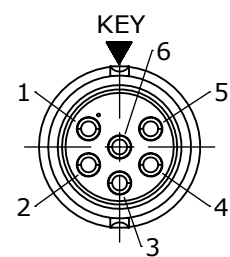

WIRING END
W6282-6PG-P-3XX

RoHS COMPLIANT

0A	PNK	05-10-19	PDR 16014
REV.	INIT.	DATE	DESCRIPTION
			ORIG. DRAWN BY: PNK DATE: 05-10-19
ALL INFORMATION ILLUSTRATED IS THE PROPERTY OF CONXALL CORPORATION. UNAUTHORIZED DUPLICATION OR DISTRIBUTION OF THIS DOCUMENT IS PROHIBITED.			
601 E. WILDWOOD VILLA PARK, IL 60181			
TITLE: CABLE-END ASSEMBLY 2-6 #20 PIN CONTACTS, SOLDER INSTA-CLICK™ MINI-CON-X			
CUSTOMER: STANDARD PRODUCT			
PART NUMBER: W6282-XPG-P-3XX			
REV 0A			