

CUSTOMER PRINT

PART NUMBER: 8380-XPG-3XX

NOTES:
1. ALL PARTS TO BE BULK PACKED

ASSY P/N	GROMMET FOR CABLE O.D.
8380-XPG-3DC	DAISY CHAIN
8380-XPG-311	0.09-0.14 [2.3-3.5mm]
8380-XPG-315	0.15-0.17 [3.8-4.3mm]
8380-XPG-318	0.18-0.20 [4.6-5.1mm]
8380-XPG-321	0.21-0.23 [5.3-5.8mm]

KIT P/N	NO. OF CONTACTS
8380-2PG-3XX	(2)-#16
8380-3PG-3XX	(3)-#16
8380-4PG-3XX	(4)-#16
8380-5PG-3XX	(5)-#16

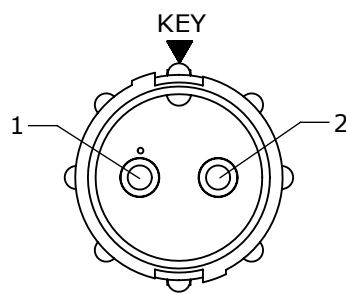

FACE VIEW
8380-2PG-3XX

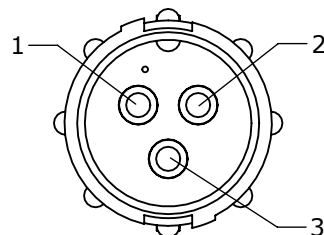

FACE VIEW
8380-3PG-3XX

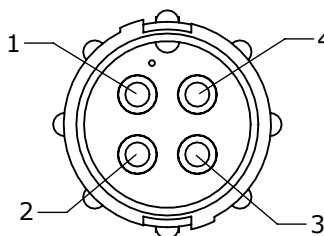

FACE VIEW
8380-4PG-3XX

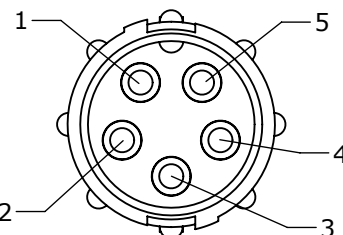

FACE VIEW
8380-5PG-3XX

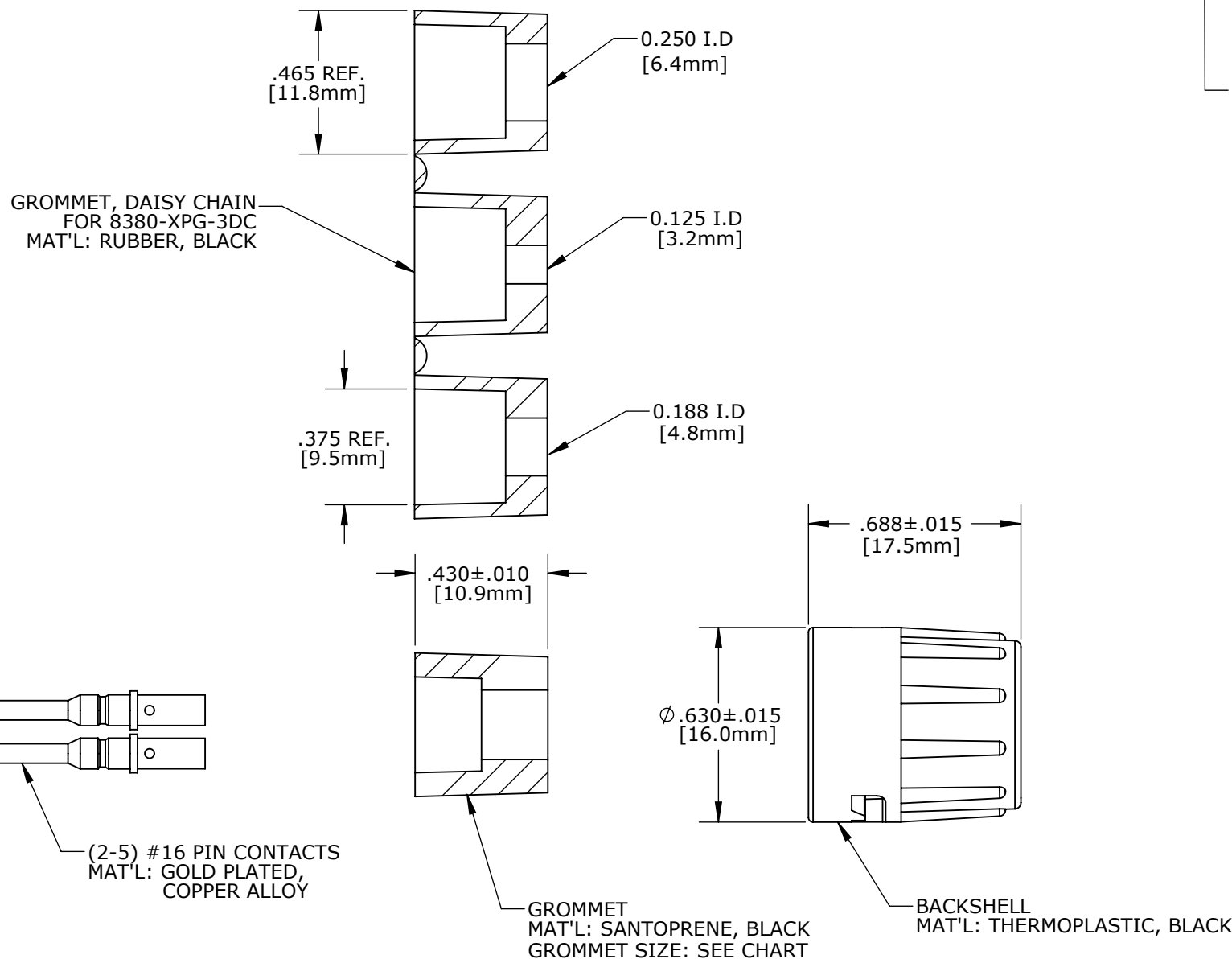
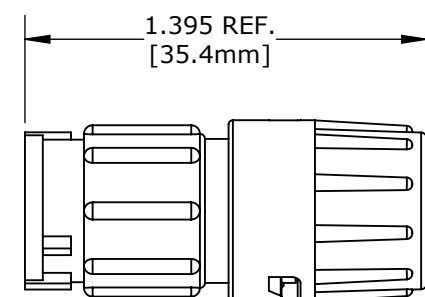
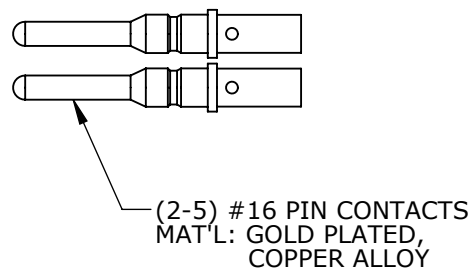
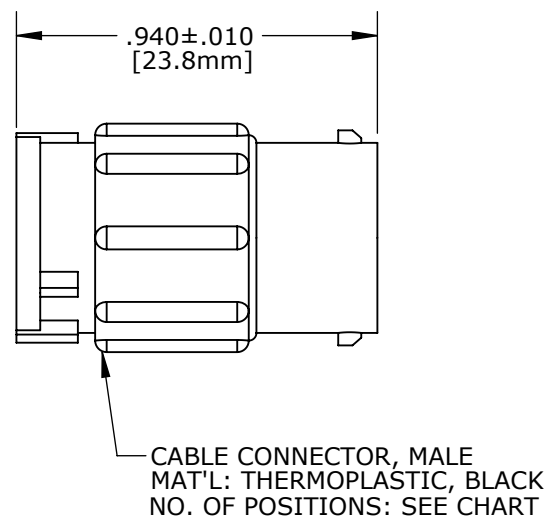

GROMMET SIZE FOR SINGLE GROMMET OR "DC" FOR DAISY CHAIN

NO. OF CONTACT

CUSTOMER APPROVAL

THIS DOCUMENT CONTAINS CONFIDENTIAL INFORMATION PROPRIETARY TO CONXALL CORPORATION. ANY REPRODUCTION, DISCLOSURE, OR USE OF THIS DOCUMENT /INFORMATION IS EXPRESSLY PROHIBITED UNLESS AUTHORIZED IN WRITING BY CONXALL CORPORATION.

APPROVED BY: _____

DATE: _____

RoHS COMPLIANT

REV.	INIT.	DATE	DESCRIPTION
A	AN	12-03-12	DRAWING CREATED PER DOR 12-E149SL #44
<small>ALL INFORMATION ILLUSTRATED IS THE PROPERTY OF "CONXALL CORPORATION". UNAUTHORIZED DUPLICATION OR DISTRIBUTION OF THIS DOCUMENT IS PROHIBITED.</small>			<small>ORIG. DRAWN BY: AN</small> <small>DATE: 11-29-12</small>
<small>ALL UNITS ARE IN FEET, INCHES, FRACTION OF INCHES AND DECIMALS. UNLESS OTHERWISE SPECIFIED TOLERANCES: 3 PLACE DECIMALS ±0.010 ANGLES ±1° FRACTIONS ±1/16</small>			<p>601 E. WILDWOOD VILLA PARK, IL 60181</p>
<small>△ - CRITICAL CHARACTERISTIC FLAG PER SPEC. XXXX</small>			
<small>SCALE: NTS</small>		<small>SIZE: B</small>	<small>SHEET: 1 OF 1</small>
<small>FILE: 8380-XPG-3XX</small>		<small>DIRECTORY: SLW</small>	<small>TITLE: CABLE TO CABLE CONN. ASSY (2-5) #16 PIN CONTACTS MINI-CON-X</small> <small>CUSTOMER: STANDARD PRODUCT</small> <small>PART NUMBER: 8380-XPG-3XX</small>
			<small>REV: A</small>

DIMENSIONS IN BRACKET [] ARE METRIC.