



MICRO-CON-X[®] 2-7

NEW PRODUCT BULLETIN C708

CONXALL[®]

A SWITCHCRAFT COMPANY



CONXALL • 601 E Wildwood • Villa Park, IL 60181 • 630-834-7504
Please visit conxall.com for the most up-to-date product specifications. Made in USA.

MICRO-CON-X® 2-7

NEW PRODUCT BULLETIN C708



FEATURES & BENEFITS

- Up to 7 contacts in compact design
- IP-67 rating, at the face, when mated
- IP-68 overmolded cable assemblies
- All plastic design is light weight
- Variety of standard options to meet all design specifications
- Custom cable assemblies available

APPLICATIONS

- Instrumentation
- Medical Equipment
- Lighting
- GPS
- Data Acquisition
- General industrial electronic applications



MICRO-CON-X[®] 2-7

NEW PRODUCT BULLETIN C708

Panel Mount / Cable to Cable Connectors

Front View | Wire View

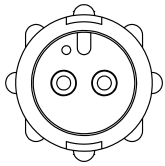

2-position
#20 Pin Contact

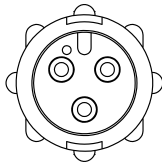

3-position
#20 Pin Contact

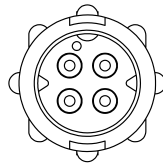

4-position
#22 Pin Contact

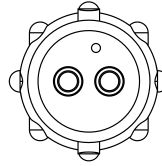

2-position
#20 Pin Contact

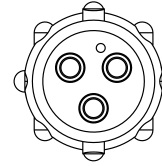

3-position
#20 Pin Contact

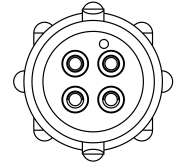

4-position
#22 Pin Contact

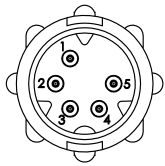

5-position B-key
#26 Pin Contact

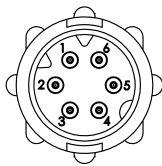

6-position A-key
#26 Pin Contact

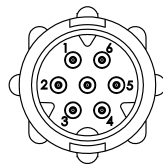

7-position B-key
#26 Pin Contact

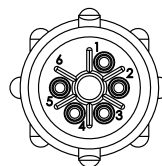

5-position B-key
#26 Pin Contact

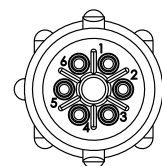

6-position A-key
#26 Pin Contact

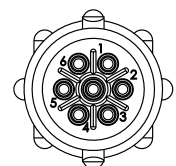

7-position B-key
#26 Pin Contact

Cable Connectors

Front View | Wire View

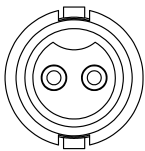

2-position
#20 Pin Contact

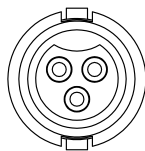

3-position
#20 Pin Contact

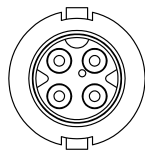

4-position
#22 Pin Contact

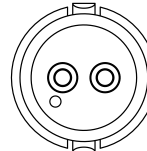

2-position
#20 Pin Contact

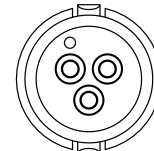

3-position
#20 Pin Contact

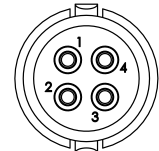

4-position
#22 Pin Contact

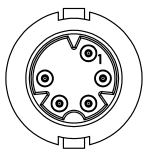

5-position B-key
#26 Pin Contact

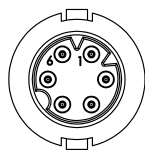

6-position A-key
#26 Pin Contact

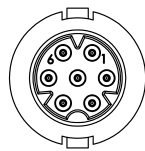

7-position B-key
#26 Pin Contact

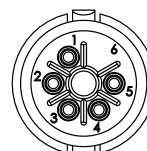

5-position B-key
#26 Pin Contact

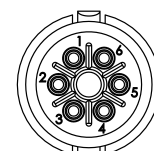

6-position A-key
#26 Pin Contact

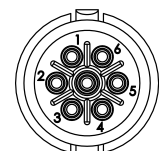

7-position B-key
#26 Pin Contact



MICRO-CON-X® 2-7

NEW PRODUCT BULLETIN C708

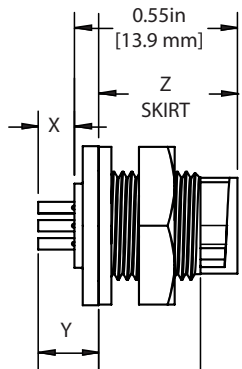

17X80-XXG-3XX

Panel Mount Connector
Crimp

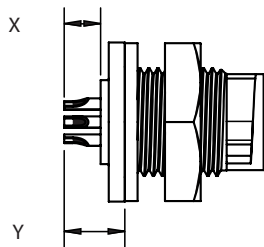

17X82-XXG-3XX

Panel Mount Connector
Solder Cup

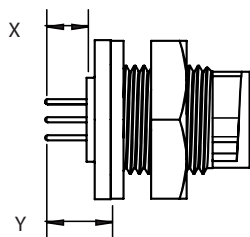

17X8X-XXG-3XX

Panel Mount Connector
PC Tail

*X, Y, Z - consult factory

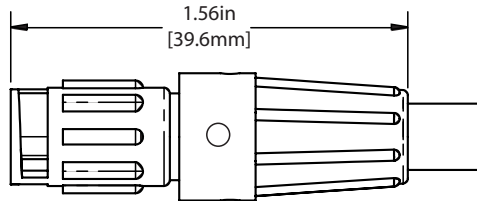

18XXX-XXG-5XX
Field Installable
Cable to Cable
Connector -
Backshell type 5 - Long

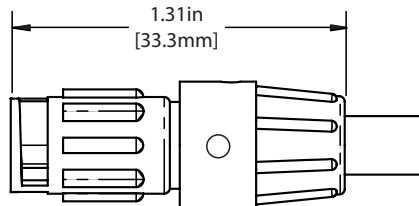

18XXX-XXG-3XX
Field Installable
Cable to Cable Connector -
Backshell type 3 - Short
2 & 3 POSTION ONLY

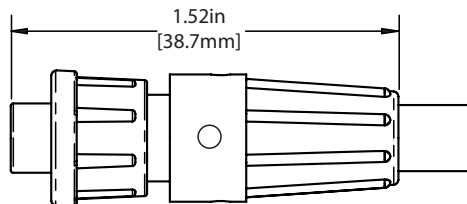

16XXX-XXG-5XX
Field Installable
Cable Connector -
Backshell Type 5 - Long

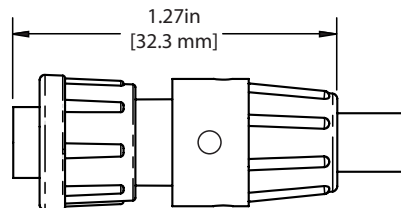

16XXX-XXG-3XX
Field Installable
Cable Connector -
Backshell Type 3 - Short
2 & 3 POSTION ONLY

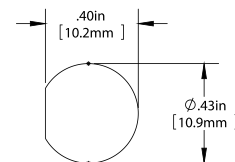
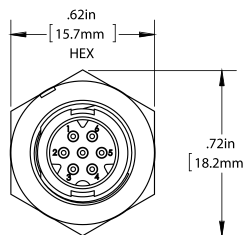

**RECOMMENDED
PANEL CUT-OUT**
TOLERANCE: ±.003

All dimensions are for reference only.



MICRO-CON-X[®] 2-7

NEW PRODUCT BULLETIN C708

SPECIFICATIONS

Mechanical Specifications

Life:	Minimum 300 insertion / withdrawal cycles without mechanical or electrical failure
Vibration:	Coupling rings have overriding locking feature to prevent loosening or separation of connector
Hex Nut Torque:	9 in-lb max tightening torque.
Coupling Locking Style:	Bayonet with ribbed coupling nut (winged coupling nut available) P/N 16482
Backshell Style:	Non-removable snap lock

Electrical Specifications

Voltage Rating:	600V AC/DC (2 and 3 pin only)
Current Rating:	7.5 A – 2 or 3 #20 contacts accepts 20 through 26 AWG
	6.0 A – 4 #22 contacts accepts 22 through 26 AWG
	4.0 A – 5 or 6 #26 contacts accepts 26 AWG
	3.5 A – 7 #26 contacts accepts 26 AWG

Environmental Specifications

Operating Temperature Rating:	-40°C to +75°C (-40°F to +149°F)
Salt Atmosphere (Corrosion):	300 Hr salt spray when mated
Weathertight:	IP67 at the face, when mated

Material Specifications

Backshell:	Thermoplastic, UL 94HB, Black
Contacts:	Copper Alloy, Gold over Nickel Plate
Coupling Ring:	Thermoplastic, UL 94HB, Black
Gasket:	Elastomer, Black
Grommet / Strain Relief:	Elastomer, Black
Hex Nut:	Thermoplastic, UL 94HB, Black
O-Ring:	Elastomer, Black
Shell:	Thermoplastic, UL 94HB, Black
Optional Dust Cap:	Elastomer, Black

Molded Cable Assemblies

Weathertight:	NEMA 6P, 13: IEC IP67
---------------	-----------------------

Certifications

UL File E150822
CSA File 181200
Not for current interruption
RoHS Compliant

Options

UV Rating:	F1 available
Flame Rating:	UL 94-HB; UL 94V-0 available

Consult factory for optional colors and materials



MICRO-CON-X[®] 2-7

NEW PRODUCT BULLETIN C708

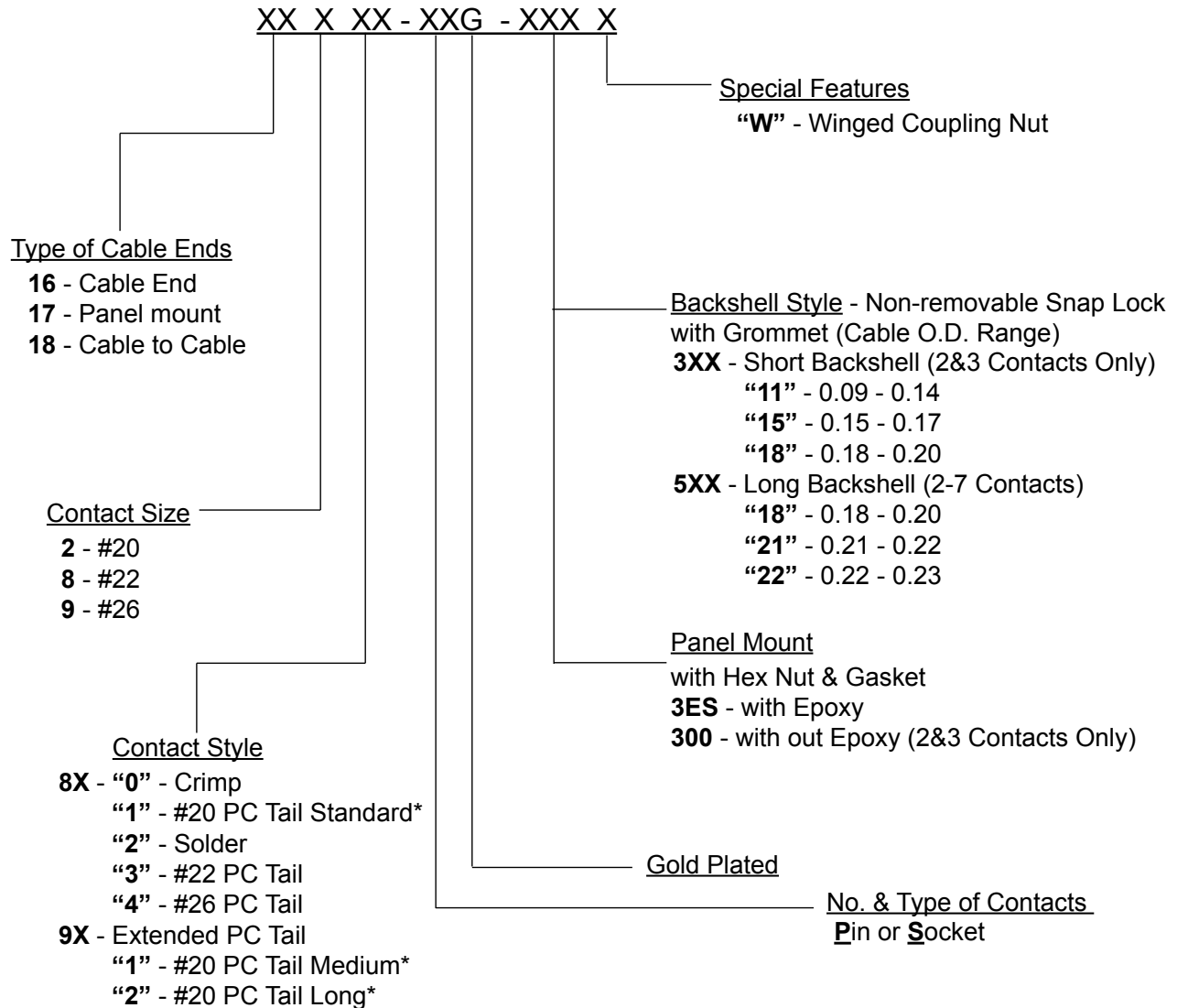

*Consult factory for length and diameter.

For alternative colors or materials, consult factory.

